



ROLLING STEEL

Product Guide & Specifications Manual

PLEASE VISIT OUR WEBSITE AT WWW.CHIOHD.COM TO SEE OUR ENTIRE LINE OF SECTIONAL AND ROLLING STEEL DOORS.

VISIT YOUR DOOR PROFESSIONAL AT:

C.H.I. Overhead Doors are manufactured in Arthur, Illinois, USA.



THE DOOR TO QUALITY.



CONTENTS

for Commercial Rolling Steel Doors

2. COMPONENTS & CONSTRUCTION

3. 6000 SERVICE & INSULATED DOORS

5. 6241 MEDIUM DUTY SERVICE DOOR

7. 7000 GUARDIAN™ FIRE DOORS

9. 7500 GUARDIAN™ FIRE SHUTTER

11. 6500 COUNTER SHUTTER

13. 9100/9200 SIDE-FOLDING GRILLES

15. 9300 LIFT READY ROLLING GRILLES

13. MOTOR OPERATORS

14. FINISH OPTIONS



C.H.I. Overhead Doors manufactures rolling steel doors and shutters to exceptional standards of quality. Our promise is to deliver an affordable, owner-friendly product that is reliable, architecturally pleasing and simple to maintain. C.H.I. rolling steel

products are engineered to provide many years of durability and trouble-free operation. Therefore, we proudly offer the longest and most comprehensive warranties in the business.

SERIES 6000 SERVICE DOORS

The Series 6000 rolling service doors are engineered and designed for maximum strength and durability. Manufactured to stringent code standards, the Series 6000 line is an industrial product built without shortcuts to provide a high degree of confidence for the specifier and end user. A wide variety of slat profiles and color options are available.

MODEL 6241 MEDIUM DUTY SERVICE DOORS

Conceived and designed as a moderately priced dock and material handling solution, the Model 6241 Service Door features full-sized 24-gauge slats and incorporates structural steel guides, full-sized headplates, structural hood, self-aligning drive bearings and Quick Release guides. The commercial design features of the Model 6241 accrue into a true feature-packed, value-added package.

SERIES 7000 FIRE DOORS

The Guardian™ Fire Door is engineered to meet ever-increasing demands of property owners and insurance underwriters in a simple to test and reset fire protection product. Utilizing standard chain hoist operation, the Guardian Fire Door features a reliable, safe, trouble-free procedure for frequent drop testing with a U.L. label rated from 3/4-hour to 4-hour protection. Manual push-up operation, Fail-Safe and automatic reset motor operation models are optional to the Guardian standard.

SERIES 7500 FIRE SHUTTER

U.L. labeled fire shutter engineered for installation to approved sheetrock, steel, and masonry construction. The Series 7500 Guardian™ fire counter shutter utilizes space-saving design with performance-proven engineering features for maximum eye appeal and fire protection.

SERIES 6500 COUNTER SHUTTER

The 6500 series offers the most in security, flexibility and appeal. Unique joint designs produce a flush curtain to achieve a seamless, clean appearance. End users, specifiers and installers recognize the 6500 Series as state-of-the-art in design, yet appreciate the simplicity and practicality that defines the product.

SERIES 9100 SIDE FOLDING GRILLES AND CLOSURES

Offering the most resourceful way to secure an opening for most any application the 9100 Series Side Folding Grilles and Closures are designed in a variety of configurations to complement surrounding architecture and allow for greater flexibility.

SERIES 9200 SIDE FOLDING EASY CLOSURE

Pre-installed in its own storage pocket including pocket door the 9200 Series offers a simple solution for storefronts and other applications. Installs quickly and can easily be adjusted on-site to fit your opening.

SERIES 9300 LIFT READY ROLLING GRILLE

The Series 9300 Lift ready is a revolutionary new design that reduces installation time and effort without compromising security. Equipped with an exclusive Smart-Lock System which allows end-users to engage the lock at a convenient height and then close the grille to the floor.

COMPONENTS & CONSTRUCTION

Commercial Rolling Steel Doors

Helicically wound torsion springs with machined castings for precise tolerances



Pre-finished 24 Ga. half hexagon hood for rigidity and aesthetics



Galvanized slats with tan or gray exterior finish coat

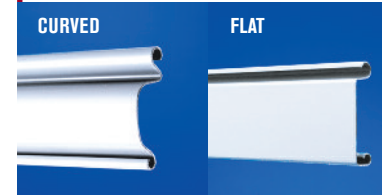

Three-angle structural steel guides prime painted standard or galvanized or powder-coated are optional



Plated steel slide bolt locks standard on push-up operated service doors



Prime painted bottom bar angles are standard with adjustable bottom astragal or optional as galvanized or powder-coated.



Malleable, zinc-plated cast iron endlocks and windlocks maintain curtain alignment and increase windload capacity

SLAT DATA

Hot-dipped galvanized slats available in pre-finished colors or powder-coat.

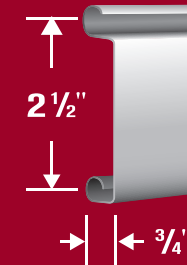

FLAT SLAT*

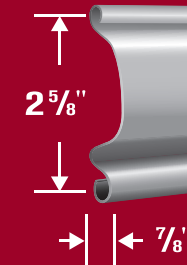

CURVED SLAT

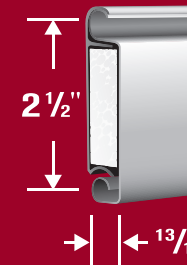

INSULATED*



*Vision Lites available for Flat or Insulated Slat doors.

SERIES 6000

Service & Insulated Doors



CLASSIC ENGINEERING

C.H.I. Rolling Service Doors are computer-engineered with time-proven principles and designs. The result is a well-tuned, high-performance coiling door.

MAXIMUM VALUE

At C.H.I. we understand that the architect, building owner, installer and service technician each seeks value with absolute reliability. The Series 6000 simplifies the process of selection by integrating the highest design principles into standard features. Simply stated, Series 6000 Service Doors are manufactured to meet your highest expectations of quality, fit and function.

DETAILS COUNT

Series 6000 Service Doors are available with curved or flat slat service curtains as well as fully weather-sealed and insulated curtains. A standard white back and hood provide a bright, light-reflecting interior surface. Guides feature a medium black primer coat that matches well with standard paint colors, as well as many powder-coat choices. Curtains are offered in solid gray, gray and white, brown and white or tan and white paint finishes. STC ratings of 25 are available when specified.

INDUSTRIAL HERITAGE

Structural steel angles are used to fabricate guides for maximum strength and durability. Curtain gauge selection may be made from 22, 20 and 18-gauge galvanized, high-tensile steel. Precision, self-aligning ball bearings support both tension and drive components. The entire spring assembly is designed for simple field removal and inspection. Hoods are formed in a half-hexagonal shape for structural rigidity and aesthetic appeal. Chain hoist operation is a standard feature, and motor operation is available with a full array of safety and activation options.

Cross-section of an insulated slat. Provided with expanded polystyrene [R=4.7] or polyurethane [R=6.7].



Note: For downloadable specifications, please visit our website at www.chiold.com or call our AIA hotline at: 800/590-0559.

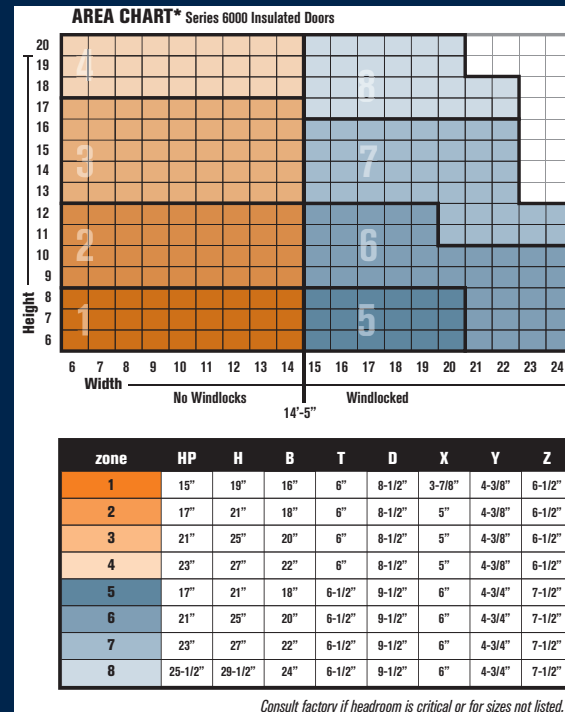

PART 1 - GENERAL

- 1.01 WORK INCLUDED:** Rolling service doors to be C.H.I. Service Series 6000, flat or curved slat.
- 1.02 RELATED SECTIONS:**
- Section 04200 Concrete Block
 - Section 05500 Metal Fabrications
 - Section 06100 Wall Construction
 - Section 08300 Access Doors
 - Section 09900 Painting
 - Section 16000 Electrical
- 1.03 SUBMITTALS:**
- Furnish all submittals according to guidelines of Section 01300 Submittal Procedures.
 - Shop Drawings: Furnish shop drawings for architectural approval including elevations and details showing dimensions, finishes, profiles and sections for each door.
 - Product Literature: Submit manufacturer's brochures and literature describing product to be used.
 - Provide manufacturer's installation instructions.
- 1.04 DELIVERY, STORAGE AND HANDLING:**
- Refer to Section 01660 Material Storage and Handling Requirements.
 - Deliver and store all materials in manufacturer provided packaging and protect from damage in a safe and dry location.
- 1.05 WINDLOAD:**
- Provide doors designed to withstand 20 pounds per square foot of windload.
 - Limit slat deflection to an amount that prevents curtain from buckling or being blown out of guides.
- 1.06 WARRANTY:** Provide manufacturer's standard five-year warranty from date of plant shipment against defects in materials and workmanship.

PART 2 - PRODUCTS

- 2.01 GENERAL:** Items and components described in the following paragraphs reflect current products manufactured by C.H.I. Overhead Doors, Inc, P.O. Box 260, Arthur, Illinois, 61911, and may be changed without notice by the manufacturer without penalty or liability.
- 2.02 CURTAIN:** Interlocking curtain slats roll-formed from 22, 20 or 18-gauge steel. Insulated curtain slats contain expanded polystyrene insulation [R=4.7] or polyurethane [R=6.7] and 24-gauge steel backers. Lateral slat movement and curtain wear controlled by galvanized, malleable cast iron endlocks fastened to every other slat. Windlocks added as dictated by door size and windload. Flat Slats: 2-1/2 inches high by 3/4 inch deep. Curved Slats: 2-5/8 inches high by 7/8 inch deep. Insulated Slats: 2-1/2 inches high by 13/16 inch deep.
- 2.03 BOTTOM BAR:** Fabricated from two steel angles bolted back-to-back, with adjustable tubular bottom astragal.
- 2.04 GUIDES:** Fabricated from three minimum 3/16 inch structural steel angles, bolted together to form guide channel.
- 2.05 HEADPLATES:** Headplates for mounting the curtain, hood, and barrel assemblies fabricated from minimum 1/4 inch steel plate. Drive side of barrel to be provided with precision, greaseable, sealed ball bearings in cast iron housing.
- 2.06 BARREL:** Barrel fabricated from minimum 4-1/2 inch O.D. steel pipe. Deflection under full load not to exceed 0.03 inches per foot of span. Barrel provided with threaded rings or lugs welded to the barrel assembly for curtain attachment.
- 2.07 SPRINGS:** Spring, (tension) assembly supported within barrel by precision ball bearings. Curtain weight counterbalanced by oil-tempered, helically wound torsion springs, grease packed and mounted to steel torsion shaft with cast spring plugs. Spring assembly designed for 20,000 cycle life standard. (Higher cycles optional.)

- 2.08 HOOD:** Hood fabricated from minimum 24-gauge steel sheet, shaped to fit within headplates. Intermediate hood support(s) furnished as required.
- 2.09 LOCKING:** Manual push-up doors furnished with interior plated steel slide bolt locks with padlock provisions. Chain hoist operated doors furnished with chain keeper suitable for padlocking.
- 2.10 OPERATION:** Manual push up, chain hoist, (standard), or motor operation.
- 2.11 FINISHES:** Curtain slats and hood hot-dipped galvanized, per ASTM A-653, G-90, with baked epoxy primer and polyester finish coat in solid gray, gray and white or tan and white. Guides and headplates shop painted black. Bottom bars to be shop painted or galvanized. Hot-dipped galvanized guides and bottom bars optional. Powder-coating is optional.

PART 3 - EXECUTION

- 3.01 EXAMINATION:**
- Examine site and notify architect of non-specified conditions or construction.
 - Advise procedures and corrections necessary to accommodate installation.
- 3.02 INSTALLATION:** C.H.I. rolling steel doors shall be installed and adjusted according to C.H.I. assembly instructions by trained door systems technicians.
- 3.03 CLEANING AND PRESENTATION:**
- Clean all finished surfaces after installation for a factory original appearance.
 - Replace any damaged components before final inspection.
 - Remove all packaging and debris from installation area at the completion of installation.
 - Present operation and maintenance instructions to owner after demonstrating proper care and operation of door.

HEADER CLEARANCES & DIMENSIONS (INCHES)

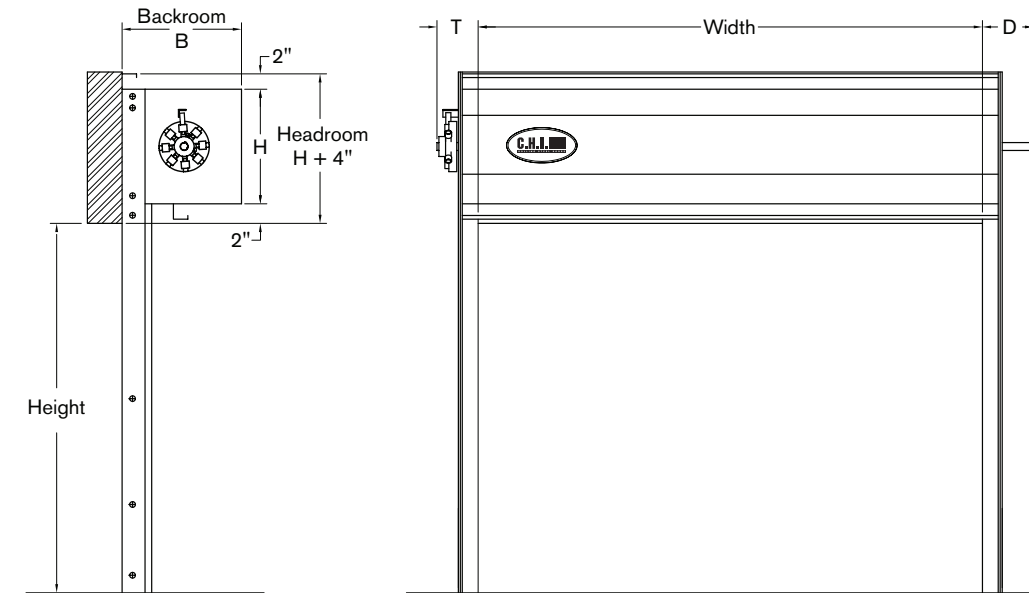

DETAILS

CLEARANCES & DIMENSIONS

- Steel
- Wood or Masonry
- Wood, Masonry or Steel

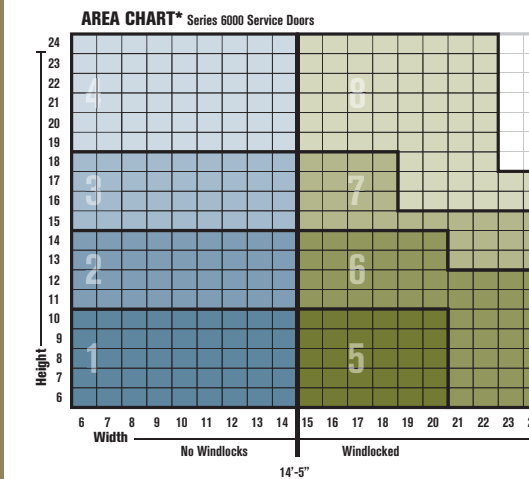
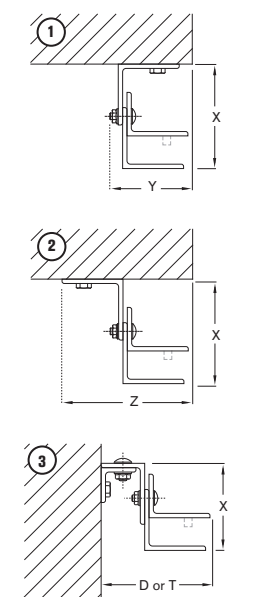

*When using Area Charts, if size falls on a zone division line, go up or right to the next zone.

MODEL 6241
Medium Duty Service Door



Loading dock and material handling locations demand a street-tough rolling service door that represents an exceptional value at a moderate price.

The Model 6241 utilizes an aggressive, yet innovative design approach to deliver sensible, high-performance features that meet these demands.

FEATURES:

- Standard sized commercial 2-1/2" interlocking flat slats in 24-gauge steel are hot-dipped galvanized, pre-painted in gray and white, and maintain high security with lighter weight and reduced cost
- Cast iron, malleable endlocks exceed industry expectations for performance and wear in a light industrial door
- Structural steel three-angle guides utilize integral bell mouths, curtain stops for higher security, maximum durability and no-hassle, simplified repair requirements
- Repairs are quickly and inexpensively expedited with common, readily available components
- Full-sized headplates provide a solid platform for chain hoist or motor operation
- Half-hexagonal formed hoods, pre-finished in white, deliver superior structural rigidity and high aesthetic appeal
- Heavy-duty, 3.5:1 chain hoists install quickly and provide a fine balance between operator effort and cycling speed
- Security is enhanced with plated slide locks for manual operation, or a chain keeper suitable for padlocking for chain hoist operation
- Value is enhanced by building real time performance expectations into time proven, reduced cost designs



SPECIFICATIONS

PART 1 - GENERAL

1.01 WORK INCLUDED: Rolling service doors to be C.H.I. Model 6241, flat slat.

1.02 RELATED SECTIONS:

- a. Section 04200 Concrete Block
- b. Section 05500 Metal Fabrications
- c. Section 06100 Wall Construction
- d. Section 08300 Access Doors
- e. Section 09900 Painting
- f. Section 16000 Electrical

1.03 SUBMITTALS:

- a. Furnish all submittals according to guidelines of Division 1.
- b. Shop Drawings: Furnish shop drawings for architectural approval including elevations and details showing dimensions, finishes, profiles and sections for each door.
- c. Product Literature: Submit manufacturer's brochures and literature describing product to be used.
- d. Provide manufacturer's installation instructions.

1.04 DELIVERY, STORAGE AND HANDLING:

- a. Refer to Division 1 Material Storage and Handling Requirements.
- b. Deliver and store all materials in manufacturer provided packaging and protect from damage in a safe and dry location.

1.05 WINDLOAD:

- a. Provide doors designed to withstand minimum 20 pounds per square foot of windload.

1.06 WARRANTY: Provide manufacturer's standard one-year warranty from date of plant shipment against defects in materials and workmanship.

PART 2 - PRODUCTS

2.01 GENERAL: Items and components described in the following paragraphs reflect current products manufactured by C.H.I. Overhead Doors, Inc, P.O. Box 260, Arthur, Illinois, 61911, and may be changed without notice by the manufacturer without penalty or liability.

2.02 CURTAIN: Standard flat curtain slats, interlocking type, roll-formed 24 gauge steel. Lateral slat movement and curtain wear controlled by galvanized, malleable cast iron endlocks fastened to every other slat. Flat Slats: 2-1/2 inches high by 3/4 inch deep.

2.03 BOTTOM BAR: Fabricated from steel angle. Bottom bar astragal is optional.

2.04 GUIDES: Fabricated from three structural steel angles, bolted together to form a guide channel and mounting angle. Quick Release guide angles include curtain stops and bellmouths integral to guides.

2.05 HEADPLATES: Headplates for mounting curtain, hood, and barrel assemblies fabricated from steel plate. Drive side of the door axle provided with self-aligning precision bearing.

2.06 BARREL ASSEMBLY: Barrel constructed from minimum 4-1/2 inch O.D. steel pipe. Deflection under full load not to exceed 0.03 inches per foot of span. Barrel provided with threaded lugs welded to barrel assembly for curtain attachment.

2.07 SPRINGS: Spring assembly fabricated with precision ball bearings supporting tension shaft assembly. Curtain weight counter-balanced by oil-tempered, helically wound torsion springs, grease packed and mounted on steel torsion shaft. Springs designed to provide 10,000 cycles. (Higher cycles rates available).

2.08 HOOD: Hood fabricated from 24-gauge steel sheet, shaped to fit within headplates.

2.09 LOCKING: Plated slide locks furnished for manual push-up operation. Chain hoist operated doors provided with chain keeper having provision for padlock.

2.10 OPERATION: Manual push up, chain hoist, or motor operation.

2.11 FINISHES: Curtain slats and hood hot-dipped galvanized, per ASTM A-653, G-60, with baked epoxy primer and polyester finish coat in gray and white. Guides and headplate shop painted black. Powder-coating optional. Bottom bars to be shop painted or galvanized.

PART 3 - EXECUTION

3.01 EXAMINATION:

- a. Examine site and notify architect of non-specified conditions or construction.
- b. Advise procedures and corrections necessary to accommodate installation.

3.02 INSTALLATION: C.H.I. rolling steel doors shall be installed and adjusted according to C.H.I. assembly instructions by trained door systems technicians.

3.03 CLEANING AND PRESENTATION:

- a. Clean all finished surfaces after installation for a factory original appearance.
- b. Replace any damaged components before final inspection.
- c. Remove all packaging and debris from installation area at the completion of installation.
- d. Present operation and maintenance instructions to owner after demonstrating proper care and operation of door.

HEADER CLEARANCES & DIMENSIONS (INCHES)

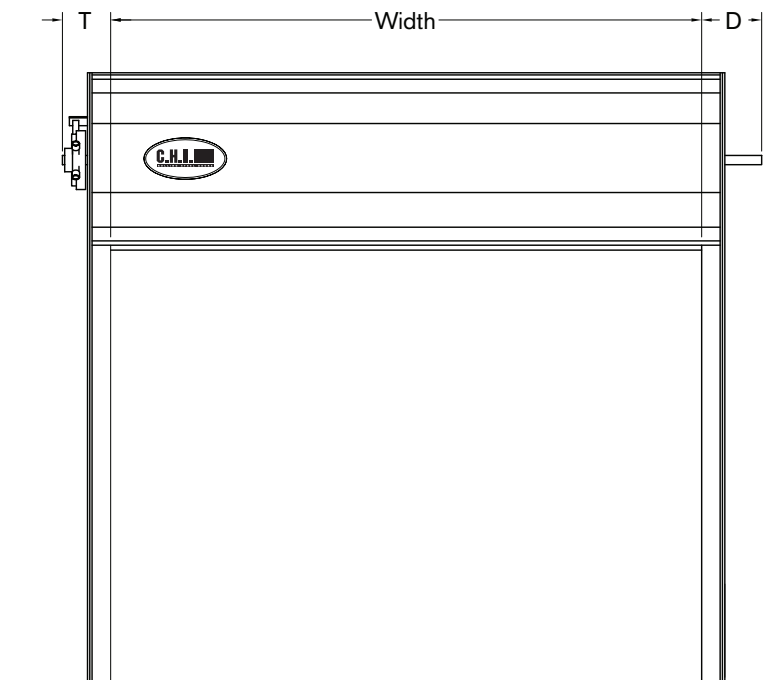
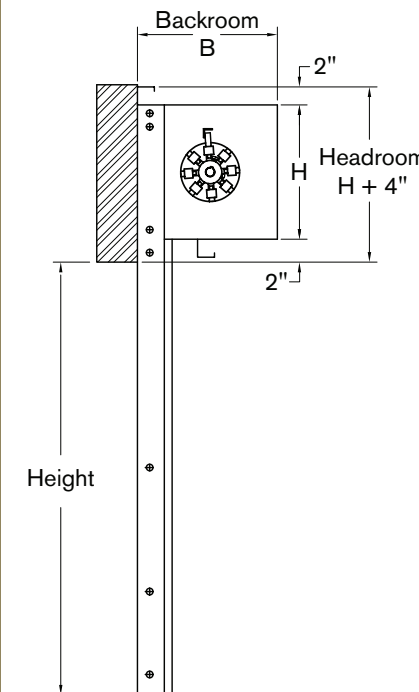

DETAILS
CLEARANCES & DIMENSIONS

- 1. Steel
- 2. Wood or Masonry

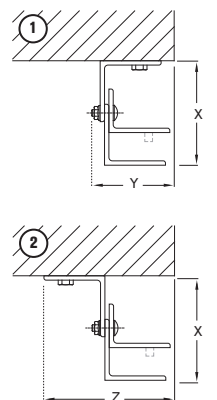

AREA CHART* Model 6241 Service Doors



zone	H	B	T	D	X	Y	Z
1	15"	16"	5"	7-1/2"	4"	2-9/16"	4-3/8"
2	17"	18"	5"	7-1/2"	4"	2-9/16"	4-3/8"

Consult factory if headroom is critical or for sizes not listed.

**When using Area Charts, if size falls on a zone division line, go up or right to the next zone.*

SERIES 7000

Guardian™ Fire Doors



A MODERN PERSPECTIVE

Guardian™ Fire Doors promote achievable standards for drop test compliance by making the job safe, understandable and simple for everyone. Simple test fire doors are our standard for chain hoist and motor operated doors.

A Solid Investment: Selected most often for practical drop test compliance and assuring positive crisis response, Guardian™ Fire Doors deliver reliable, predictable and repeatable results.

An Exceptional Choice: The National Fire Protection Association and other model codes recommend frequent drop testing of fire doors to assure a continuous state of operational readiness. C.H.I. strongly promotes these recommendations with the Guardian's™ advanced design features:

FEATURES:

- Safe, simple, inexpensive and repeatable drop testing is now made possible in any facility with a flip of a handle
- No ladders, tools or equipment are required to drop test and reset Guardian™ Simple Test Fire Doors
- Drop speed is controlled by a quiet governor between 6" to 24" per second
- Gear reduced chain hoist operation is standard, efficient and economical
- Manual push-up operation and fail-safe motor operation is optional
- 165 degree fusible links are provided as standard detection/release devices
- U.L. Labels are provided from 3/4-hour to 4-hour for labeled and oversized doors
- Guides mount to approved masonry, steel and sheetrock construction
- Upward-expanding guides may be welded to approved steel construction
- Fail-safe time delayed releases, smoke detectors and audible and visual warning systems are optional
- Installation time is reduced significantly due to the elimination of complicated release and governor assemblies
- Curved or flat slat profiles are offered in pre-painted, galvanized or powder-coated options

GUARDIAN™ FIRE DOORS CARRY STANDARD LISTING OR OVERSIZE U.L. LABELS.

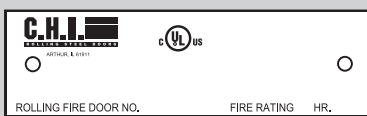

C.H.I. Listing Label

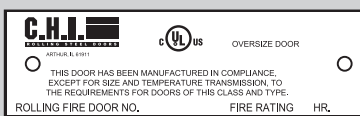

C.H.I. Oversize Label



SPECIFICATIONS

PART 1 - GENERAL

1.01 WORK INCLUDED: Rolling steel fire doors to be C.H.I. Guardian™ Series 7000, and comply with Underwriter's Laboratories requirements for 4, 3, 1-1/2, and 3/4-hour exterior or interior locations.

1.02 RELATED SECTIONS:

- Section 04200 Concrete Block
- Section 05500 Metal Fabrications
- Section 06100 Wall Construction
- Section 08300 Access Doors
- Section 09900 Painting
- Section 16000 Electrical

1.03 SUBMITTALS:

- Furnish all submittals according to guidelines of Division 1 Submittal Procedures.
- Shop Drawings: Furnish shop drawings for architectural approval including elevations and details showing dimensions, finishes, profiles and sections for each door.
- Product Literature: Submit manufacturer's brochures and literature describing product to be used.
- Provide manufacturer's installation instructions.

1.04 DELIVERY, STORAGE AND HANDLING:

- Refer to Division 1 Material Storage and Handling Requirements.
- Deliver and store all materials in manufacturer provided packaging and protect from damage in a safe and dry location.

1.05 WINDLOAD:

- Provide doors designed to withstand minimum 20 pounds per square foot of windload.
- Provide higher windload options.
- Limit slat deflection to an amount that prevents curtain from buckling or being blown out of guides.

1.06 WARRANTY: Provide manufacturer's standard five-year warranty from date of plant shipment against defects in materials and workmanship. Manufacturer's brochures and literature describing product to be used.

PART 2 - PRODUCTS

2.01 GENERAL: Items and components described in the following paragraphs reflect current products manufactured by C.H.I. Overhead

Doors, Inc, P.O. Box 260, Arthur, Illinois, 61911, and may be changed without notice by the manufacturer without penalty or liability.

2.02 CURTAIN: Interlocking curtain slats of roll-formed 22, 20 or 18-gauge steel. Lateral slat movement and curtain wear controlled by galvanized, malleable cast iron endlocks fastened to every other slat. Windlocks added as dictated by windload requirements. Flat Slats: 2-1/2 inches by 3/4 inch deep. Curved Slats: 2-5/8 inches by 7/8 inch deep.

2.03 BOTTOM BAR: Bottom bar fabricated from steel angle. (Tubular bottom seal optional.)

2.04 GUIDES: Guides fabricated from three minimum 3/16 inch structural steel angles, bolted together to form guide channel and wall mounting angle.

2.05 HEADPLATES: Headplates for mounting the curtain, hood, and barrel assemblies fabricated from minimum 1/4 inch steel plate. Drive axle provided with precision, greaseable, sealed ball bearings in cast iron housing.

2.06 BARREL: Barrel constructed from minimum 4-1/2 inch O.D. steel pipe. Deflection under full load not to exceed 0.03 inches per foot of span. Barrel provided with threaded rings or lugs welded to barrel assembly for curtain attachment.

2.07 SPRINGS: Spring, (tension) assembly supported within barrel by precision bearings. Curtain weight counterbalanced by oil-tempered, helically wound torsion springs, grease packed and mounted to steel torsion shaft with cast spring plugs. Spring assembly designed for 20,000 cycle life standard. (Higher cycles optional.)

2.08 HOOD: Half-hex hood formed of minimum 24-gauge steel sheet, shaped to fit within headplates. Intermediate hood support(s) furnished as required.

2.09 LOCKING: Chain hoist operated doors provided with chain keeper having provisions for padlocking. Plated slide locks optional.

2.10 OPERATION: Gear reduced chain hoist operation standard. Motor operation or manual push-up operation is optional. Manual push-up operation does not include simple test feature.

2.11 AUTOMATIC CLOSURE: 165-degree fusible links provided as standard. Closing speed regulated by centrifugal or viscous governor. Drop speed to be between 6" and 24" per second per NFPA-80.

2.12 OPERATION: Manual push-up, (without simple test feature), chain hoist or electric motor.

2.13 DROP TESTING: Floor level release and reset handle. Drop test activated by raising release handle. Reset assembly by securing the release handle to original starting position. No ladders or tools shall be needed to drop test or reset door. Manual push-up door drop tested by partial tension release and requires reset by a qualified door technician.

2.14 FINISHES: Curtain slats and hood hot-dipped galvanized, per ASTM A-653, G-90, with baked epoxy primer and polyester finish coat in solid gray, gray and white or tan and white. Guides and headplates shop painted black. Powder-coating optional. Bottom bars to be shop painted or galvanized.

PART 3 - EXECUTION

3.01 EXAMINATION:

- Examine site and notify architect of non-specified conditions or construction.
- Advise procedures and corrections necessary to accommodate installation.

3.02 INSTALLATION: C.H.I. rolling steel doors shall be installed and adjusted according to C.H.I. assembly instructions by trained door systems technicians.

3.03 CLEANING AND PRESENTATION:

- Clean all finished surfaces after installation for a factory original appearance.
- Replace any damaged components before final inspection.
- Remove all packaging and debris from installation area at the completion of installation.

3.04 DROP TESTING:

- Upon installation, door shall be drop tested before appropriate witnesses to attest to successful drop operation and reset.
- Complete the Rolling Fire Door Inspection and Drop Test form that accompanies each door.
- Present operation and maintenance instructions to owner after demonstration, drop test and reset is witnessed.

3.05 SCHEDULED TESTING: NFPA-80 and model code groups mandate annual inspection and drop testing of fire doors to check for proper operation and full closure.

GUARDIAN™ CHAINHOISTER HEADER CLEARANCES & DIMENSIONS (INCHES)

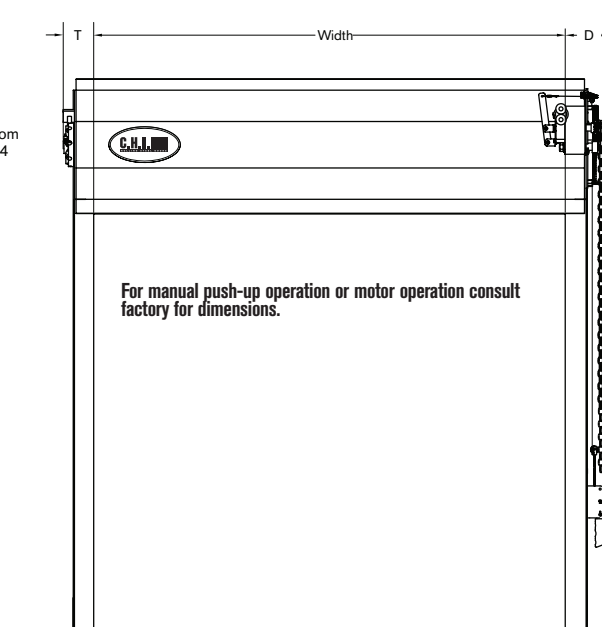
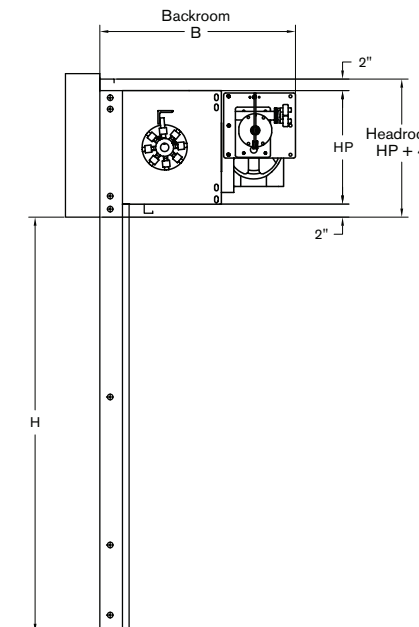

DETAILS

CLEARANCES & DIMENSIONS

- Steel
- Wood or Masonry
- Wood, Masonry or Steel

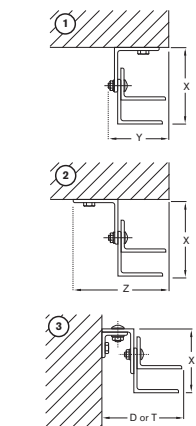

NOTE: Grifco Governor requires 12" of backroom.

*When using Area Charts, if size falls on a zone division line, go up to the next zone.

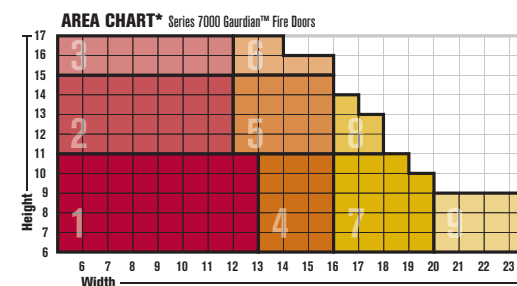

zone	H	B	T	D	X	Y	Z
1	15"	28"	6-1/2"	7-1/2"	3-7/8"	4-3/8"	6-1/2"
2	17"	30"	6-1/2"	7-1/2"	3-7/8"	4-3/8"	6-1/2"
3	19"	32"	6-1/2"	7-1/2"	5"	4-3/8"	6-1/2"
4	15"	28"	7"	8"	4-1/4"	4-3/4"	7"
5	17"	30"	7"	8"	4-1/4"	4-3/4"	7"
6	19"	32"	7"	8"	5"	4-3/4"	7"
7	15"	28"	7-1/2"	8-1/2"	5"	5-1/4"	7-1/2"
8	17"	30"	7-1/2"	8-1/2"	5"	5-1/4"	7-1/2"
9	19"	32"	7-1/2"	8-1/2"	5"	5-1/4"	7-1/2"

Consult factory if headroom is critical or for sizes not listed.



SERIES 7500
Fire Shutter

Fire protection manufactured to the highest standards, C.H.I. fire shutters feature attractive, space-saving designs and user-friendly operation.

U.L. labeled for installation to approved sheetrock, masonry and steel construction, Series 7500 Fire Shutters meet all U.L. requirements for counter and window openings.

FEATURES:

- 45-minute, 90-minute and 3-hour U.L. labels with full compliance to NFPA-80 standards
- Standard curtain features 1-1/2" pre-painted, hot-dipped galvanized steel slats
- Optional stainless steel curtain and guides available in a #4 finish
- Shop painted guides in a medium gloss black matches well with many powder-coat options
- Reliable viscous governor provides smooth, quiet drop testing
- Easily drop tested and reset with a minimum of downtime to assure operational readiness
- Designed for face of wall mount and between-jamb mounting configurations.
- Manual push-up operation is standard fore all fire shutters up to 10' x 8' and the gear reduced awning crank operation is optional - all larger fire shutters it is standard
- Bottom bar slide bolt locks are standard with cylinder locking optional.
- 165-degree fusible links are provided as standard detection/release devices
- May be installed with all approved detection and release devices
- Attractive, compact hood is designed for maximum efficiency in tight areas

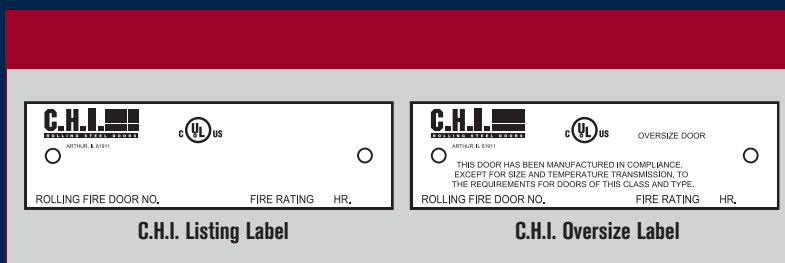
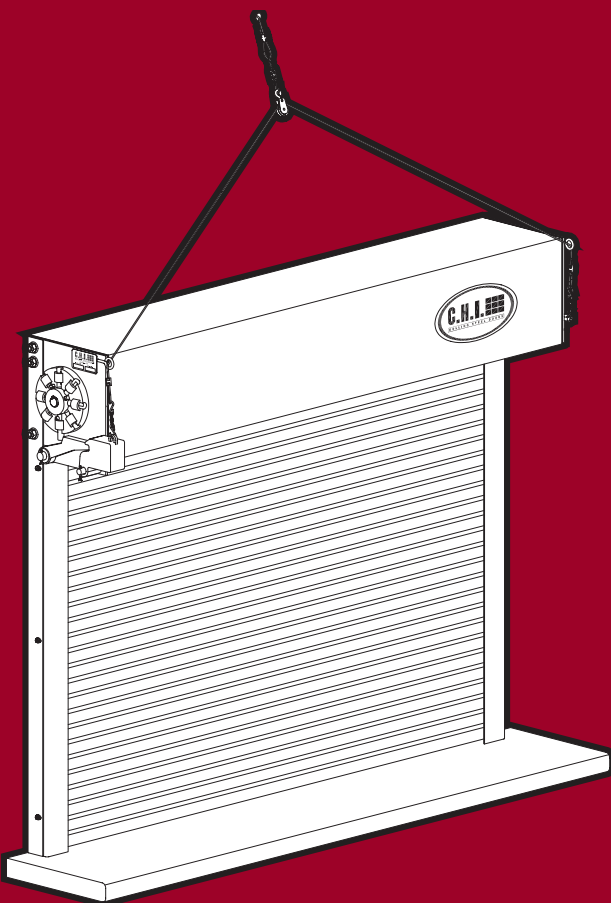

SPECIFICATIONS

PART 1 - GENERAL

1.01 WORK INCLUDED: Rolling shutters to be C.H.I. Fire Shutter Series 7500 and comply with Underwriter's Laboratories requirements for 3, 1-1/2 and 3/4-hour locations.

1.02 RELATED SECTIONS:

- Section 04200 Concrete Block
- Section 05500 Metal Fabrications
- Section 06100 Wall Construction
- Section 08300 Access Doors
- Section 09900 Painting
- Section 16000 Electrical

1.03 SUBMITTALS:

- Furnish all submittals according to guidelines of Section 01300 Submittal Procedures.
- Shop Drawings: Furnish shop drawings for architectural approval including elevations and details showing dimensions, finishes, profiles and sections for each door.
- Product Literature: Submit manufacturer's brochures and literature describing product to be used.
- Provide manufacturer's installation instructions.

1.04 DELIVERY, STORAGE AND HANDLING:

- Refer to Division 1 Material Storage and Handling Requirements.
- Deliver and store all materials in manufacturer provided packaging and protect from damage in a safe and dry location.

1.05 WARRANTY: Provide manufacturer's standard five-year warranty from date of plant shipment against defects in materials and workmanship. Manufacturer's brochures and literature describing product to be used.

PART 2 - PRODUCTS

2.01 GENERAL: Items and components described in the following paragraphs reflect current products manufactured by C.H.I. Overhead Doors, Inc, P.O. Box 260, Arthur, Illinois, 61911, and may be changed without notice by the manufacturer without penalty or liability.

2.02 CURTAIN: Interlocking curtain slats of roll-formed 22-gauge steel. Lateral slat movement and curtain wear controlled by galvanized, malleable cast iron endlocks fastened to every other slat. Windlocks added as dictated by windload requirements. Lateral slat movement and curtain wear controlled by malleable cast iron endlocks fastened to every other slat. Flat slat profile is 1-1/2 inches high by 1/2 inch deep.

2.03 BOTTOM BAR: Bottom bar steel or stainless steel angle, bolted to curtain.

2.04 GUIDES: Box shaped guides fabricated from 11-gauge steel or stainless steel with integral bellmouths and curtain stops.

2.05 HEADPLATES: Headplates for mounting curtain, hood, and barrel assemblies fabricated from minimum 1/4 inch steel plate. Drive axle provided with precision, self-aligning bearings.

2.06 BARREL: Barrel constructed from minimum 4-1/2 inch O.D. steel pipe. Deflection under full load not to exceed 0.03 inches per foot of span. Barrel provided with threaded rings or lugs welded to barrel assembly for curtain attachment.

2.07 SPRINGS: Spring (tension) end of barrel assembly fabricated with self-aligning ball bearing assembly to support barrel assembly. Curtain weight counterbalanced by oil-tempered, helically wound torsion springs, grease packed and mounted on steel torsion shaft.

2.08 HOOD: Rectangular hood formed of minimum 24-gauge steel sheet, shaped to fit within headplates. Intermediate hood support(s) furnished as required.

2.09 LOCKING: Manual push up shutters furnished with interior slide bolt locks suitable for padlocking. Awning crank operated shutters supplied without locks unless specified.

2.10 OPERATION: Manual push up operation is standard through ten feet wide. Awning crank operation available for all sizes.

2.11 AUTOMATIC CLOSURE: Thermally activated by 165-degree fusible link, or optional time delay releases. Closing speed regulated by viscous governor to between 6 inches and 24 inches per second, per NFPA-80 standards.

2.12 FINISHES: Steel curtain slats and hood hot-dipped galvanized, per ASTM A-653, G-90, with baked epoxy primer and polyester finish coat in gray and white. Guides and headplates shop painted medium gloss black. #4 stainless curtain, guides, bottom bar and hood optional. Powder-coating optional. Bottom bars to be shop painted steel, stainless steel, galvanized or powder-coated.

PART 3 - EXECUTION

3.01 EXAMINATION:

- Examine site and notify architect of non-specified conditions or construction.
- Advise procedures and corrections necessary to accommodate installation.

3.02 INSTALLATION: C.H.I. rolling fire shutters shall be installed and adjusted according to C.H.I. assembly instructions by trained door systems technicians.

3.03 CLEANING AND PRESENTATION:

- Clean all finished surfaces after installation for a factory original appearance.
- Replace any damaged components before final inspection.
- Remove all packaging and debris from installation area at the completion of installation.

3.04 DROP TESTING:

- Upon installation, door shall be drop tested before appropriate witnesses to attest to successful drop operation and reset.
- Complete the Rolling Fire Door Inspection and Drop Test form that accompanies each door.
- Present operation and maintenance instructions to owner after demonstrations, drop tests and reset is witnessed.

3.05 SCHEDULED TESTING: NFPA-80 and model code groups mandate annual inspection and drop testing of fire doors to check for proper operation and full closure.

HEADER CLEARANCES & DIMENSIONS (INCHES)

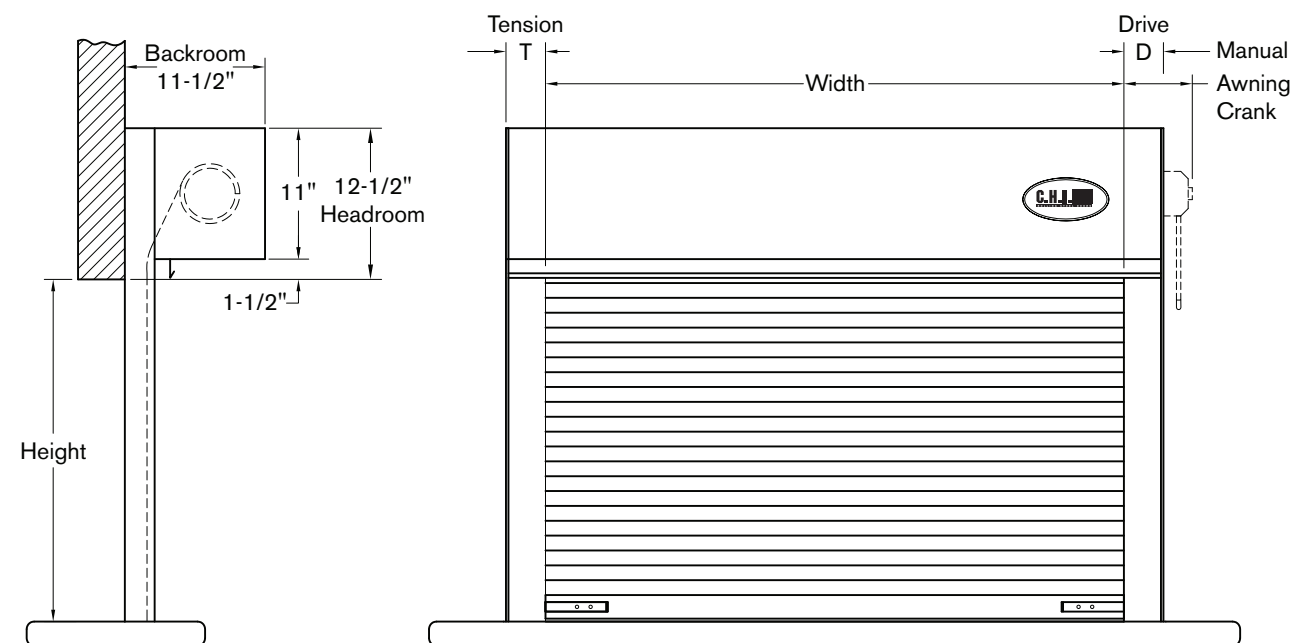

Face of Wall Mount

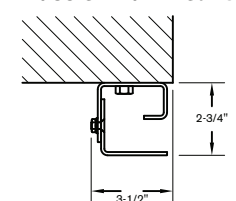

	D	T
Manual	5-1/2"	6-1/2"
Awning Crank	7-1/2"	6-1/2"

Between Jamb Mount

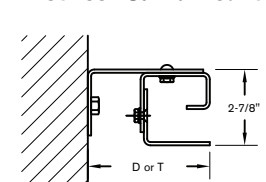

	D	T
Manual	5-1/2"	6-1/2"
Awning Crank	7-1/2"	6-1/2"

SERIES 6500

Counter Shutter



Security and beauty blended with smooth, quiet and effortless operation, the C.H.I. Series 6500 counter shutter is a wonderfully refined, architecturally pleasing enclosure.

FEATURES:

- The Model 6544 features a clear anodized, extruded aluminum curtain and guides
- The Model 6522 features a painted steel curtain with clear anodized, extruded aluminum guides
- The Model 6566 features a stainless steel curtain with a #4 finish and stainless steel "J" guides
- Blemish-free exterior: The Models 6544 and 6522 feature hidden headplates, guides and wall fasteners for a well-blended, architecturally sensitive appearance
- Visible seams and shadow lines are eliminated from extruded aluminum guides due to unique joint designs
- Soft brush guide runners silence curtain operation and seal out dust and noise
- Dual-bottom bar seal assures a soft, non-marring touch down to valuable counter tops
- Thumb turn locks are spring assisted, and secure each side of the bottom bar into hidden recesses in the guides. Cylinder locking is optional for each side
- Integral lift rails on the bottom bar provide full-width manual access and simplified lifting
- Invisible tubular motor operation, awning crank operation, or exterior mount motor is optional
- Compact in design, the Series 6500 installs into minimum head and side room dimensions



Optional high torque tubular motor for non-visible, dependable operation.

SPECIFICATIONS

PART 1 - GENERAL

1.01 WORK INCLUDED: Rolling counter shutters to be C.H.I. Series 6500.

1.02 RELATED SECTIONS:

- Section 04200 Concrete Block
- Section 05500 Metal Fabrications
- Section 06100 Wall Construction
- Section 08300 Access Doors
- Section 09900 Painting
- Section 16000 Electrical

1.03 SUBMITTALS:

- Furnish all submittals according to guidelines of Division 1 Submittal Procedures.
- Shop Drawings: Furnish shop drawings for architectural approval including elevations and details showing dimensions, finishes, profiles and sections for each door.
- Product Literature: Submit manufacturer's brochures and literature describing product to be used.
- Provide manufacturer's installation instructions.

1.04 DELIVERY, STORAGE AND HANDLING:

- Refer to Division 1 Material Storage and Handling Requirements.
- Deliver and store all materials in manufacturer provided packaging and protect from damage in a safe and dry location.

1.05 WARRANTY: Provide manufacturer's standard five-year warranty from date of plant shipment against defects in materials and workmanship.

PART 2 - PRODUCTS

2.01 GENERAL: Items and components described in the following paragraphs reflect current products manufactured by C.H.I. Overhead Doors, Inc, P.O. Box 260, Arthur, Illinois, 61911, and may be changed without notice by the manufacturer without penalty or liability.

2.02 CURTAIN: Extruded, interlocking aluminum slats, interlocking roll-formed slats in 22-gauge steel, or interlocking roll-formed slats in 22-gauge stainless steel. Lateral slat movement and curtain wear controlled by nylon endlocks fastened to every other slat. Windlocks added as dictated by shutter size and windload requirements. Slat profile is 1-1/2 inches high by 1/2 inch deep.

2.03 BOTTOM BAR: Extruded aluminum with integral lift rails and dual bottom astragal standard for aluminum and steel curtains. Stainless steel angle with bottom astragal provided for stainless curtains.

2.04 GUIDES: Extruded, clear anodized aluminum. Box shaped, two-piece configuration with soft brush guide runners, bell mouths and travel stops. Guides for stainless steel are box shaped, #4 stainless steel with integral bell mouths and curtain stops.

2.05 HEADPLATES: Headplates for mounting curtain, hood, and barrel assemblies fabricated from steel plate. Drive axle supported by precision, self-aligning bearings.

2.06 BARREL: Barrel constructed from minimum 4-1/2 inch O.D. steel pipe. Deflection under full load not to exceed 0.03 inches per foot of span. Barrel provided with threaded rings or lugs welded to barrel assembly for curtain attachment.

2.07 SPRINGS: Spring (tension) end of barrel assembly fabricated with self-aligning ball bearing assembly to support barrel assembly. Curtain weight counterbalanced by oil-tempered, helically wound torsion springs, grease packed and mounted on steel torsion shaft.

2.08 HOOD: Rectangular hood formed of minimum 24-gauge steel, aluminum or stainless steel sheet, shaped to fit within headplates. Intermediate hood support(s) furnished as required.

2.09 LOCKING: Manual push-up doors furnished with thumb turn locks. Stainless steel slide locks provided with stainless curtains. Keyed thumb turn and cylinder locking optional.

2.10 OPERATION: Manual push up. Reduced drive awning crank operation, concealed tube motor operation and outside motor operation optional.

2.11 FINISHES: Extruded aluminum curtain, guides and bottom bar to be clear anodized. Steel curtain slats and hood hot-dipped galvanized, per ASTM A-653, G-90, with baked epoxy primer and polyester finish coat in gray and white. Painted curtains furnished with clear anodized extruded aluminum box guides and bottom bar. Stainless shutters furnished with #4 polished finish curtain, guides and bottom bar. Powder-coating optional for all steel and aluminum components.

PART 3 - EXECUTION

3.01 EXAMINATION:

- Examine site and notify architect of non-specified conditions or construction.
- Advise procedures and corrections necessary to accommodate installation.

3.02 INSTALLATION: C.H.I. rolling steel doors shall be installed and adjusted according to C.H.I. assembly instructions by trained door systems technicians.

3.03 CLEANING AND PRESENTATION:

- Clean all finished surfaces after installation for a factory original appearance.
- Replace any damaged components before final inspection.
- Remove all packaging and debris from installation area at the completion of installation.
- Present operation and maintenance instructions to owner after demonstrating proper care and operation of door.

HEADER CLEARANCES & DIMENSIONS (INCHES)

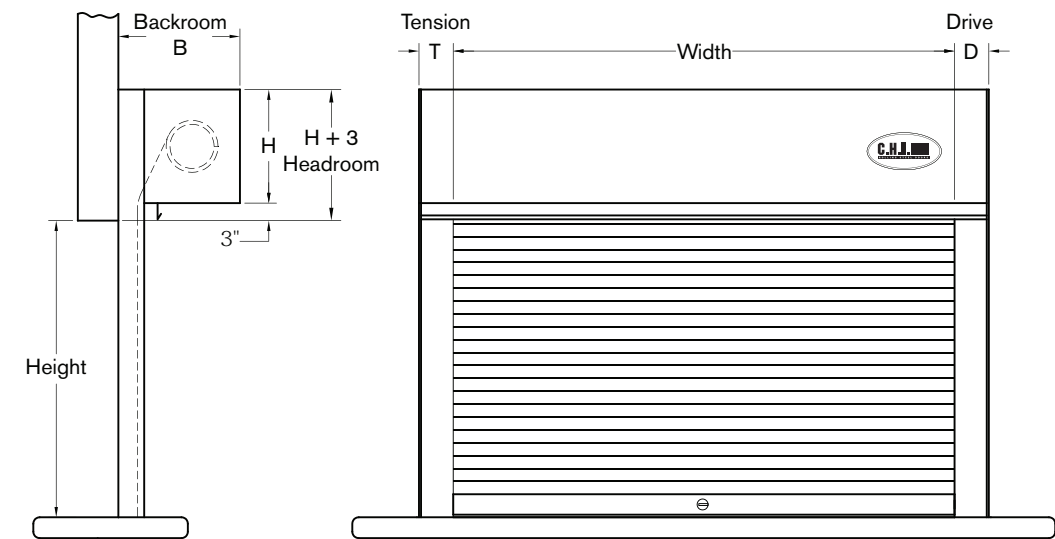

AREA CHART* Series 6500 Counter Shutters

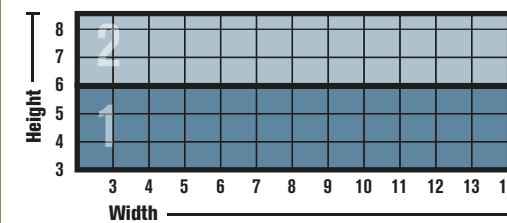

zone	H	B
1	10"	10-1/2"
2	11"	11-1/2"

Face of Wall Mount

Aluminum & Steel

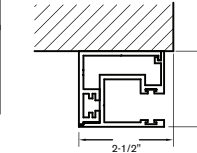

	D	T
Manual	2-1/2"	2-1/2"
Awning Crank	4-1/2"	2-1/2"
Motor	2-1/2"	2-1/2"

Between Jamb Mount

Aluminum & Steel

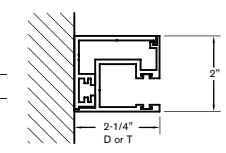

	D	T
Manual	2-1/4"	2-1/4"
Awning Crank	4-1/4"	2-1/4"
Motor	4-1/4"	2-1/4"

Face of Wall Mount

Stainless Steel

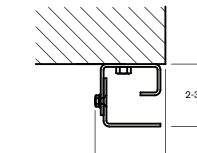

	D	T
Manual	3-1/2"	3-1/2"
Awning Crank	5-1/2"	3-1/2"
Motor	5-1/2"	3-1/2"

Between Jamb Mount

Stainless Steel

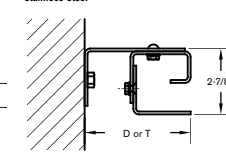

	D	T
Manual	4-1/2"	4-1/2"
Awning Crank	6-1/2"	4-1/2"
Motor	6-1/2"	4-1/2"

Consult factory if headroom is critical or for sizes not listed.

9100/9200 SERIES

Side-Folding Grilles & Closures



With no limit on width and numerous track layouts, there are virtually no openings that can not be secured with a side folding grille/closure. Standard curves as well as special curves give the designer the ability to follow most any line for maximum space advantage and three body widths allows for customizing stack/pocket dimensions. Top supported design eliminates a bottom track reducing maintenance and makes manual operation quick and easy. While the standard clear anodized finish, gives a durable, finished appearance and emergency exits are available when required.

Specify the 9100 for larger openings, complicated layouts and the maximum design options including 15 patterns and designs, such as Link and Rod, Tempered Glass, Polycarbonate, Perforated Aluminum or Solid Aluminum panels.

For smaller, simpler layouts specify the 9200. Available in four patterns including: Link and Rod Straight or Staggered (Brick), Perforated Aluminum or Solid Aluminum panels. The 9200 also comes with a steel pocket frame and PVC pocket door! The pocket is sized to match a standard 6" metal stud offering a smooth transition and fast installation.

Available designs:

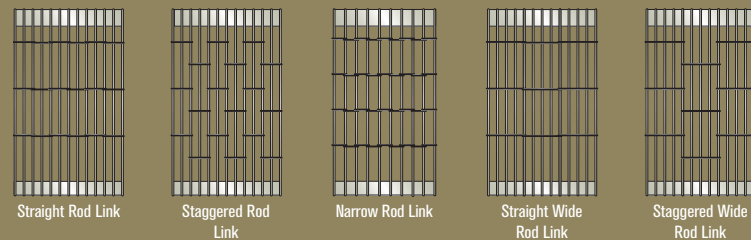

SPECIFICATIONS

PART 1 - GENERAL

1.01 WORK INCLUDED: Side folding aluminum grilles/closures to be C.H.I. Series 9100/9200.

1.02 RELATED SECTIONS:

- Division 01: Administrative, procedural, and temporary work requirements
- Section 05500 Metal Fabrication
- Section 07700 Door Hardware
- Section 08300 Access Doors

1.03 SUBMITTALS

- Furnish all submittals according to guidelines of Division 1 Submittal Procedures.
- Shop Drawings: Furnish shop drawings for architectural approval including elevations and details showing dimensions, finishes, patterns and sections for each grille/closure.
- Product Literature: Submit manufacturer's brochures and literature describing product to be used.
- Provide manufacturer's installation instructions.

1.04 DELIVERY < STORAGE < AND HANDLING

- Refer to Division 1 Material Storage and Handling Requirements
- Deliver and store all materials in manufacturer provided packaging and protect from damage in a safe and dry location.

1.05 WARRANTY: Provide manufacturer's standard two-year warranty from date of plant shipment against defects in materials and workmanship.

PART 2 - PRODUCTS

2.01 GENERAL: Items described in the following paragraphs reflect current products manufactured by C.H.I. Overhead Doors, Inc., P.O. Box 260, Arthur, IL, 61911, and may be changed without notice by the manufacturer without penalty or liability.

2.02 ROD & LINK STANDARD CURTAIN (9100 or 9200): 6-5/16 inches wide with 5-1/4 inch high bottom and top plates, truss-like aluminum. Panels connected with 1/8 x 5/8 inch x 6 inch aluminum links vertically spaced 12 inches apart on 5/16 inch aluminum rods spaced horizontally 3 inches apart; every other rod covered with 1/2 inch aluminum tubes.

- Pattern: Straight ***OR*** Staggered (Brick). ***OR***

2.02 ROD & LINK WIDE BODY CURTAIN (9100): 11-1/4 inches wide with 5-1/4 inch high bottom and top plates, truss-like aluminum and 1 inch wide intermediate aluminum plates vertically spaced 12 inches apart; three 15/16 inch vertical rods horizontally spaced 1-7/8 inches on center, covered with 1/2 inch aluminum tubes. Panels connected with two-piece vertical aluminum tubular hinges.

- Pattern: Straight ***OR*** Staggered (Brick). ***OR***

2.02 ROD & LINK NARROW BODY CURTAIN (9100): 4-1/4 inches wide with 2 inch high bottom and top plates, truss-like aluminum. Panels connected with 1/8 x 5/8 x 4-1/4 inch aluminum links vertically spaced 15 inches apart on 5/16 inch aluminum rods horizontally spaced 3-1/2 inches on center; every other rod covered with 1/2 inch aluminum tube.

- Pattern: Straight. ***OR***

2.02 GLASS STANDARD BODY CURTAIN (9100): 7-1/4 inches wide with minimum 4 inch high bottom and 5-1/4 inch high top plates, truss-like aluminum, glazed with 1/8 inch thick tempered glass vertically spaced by 1 inch truss-like aluminum plates, 4-3/4 inch wide per-panel viewable area. Panels connected with two-piece vertical aluminum tubular hinges.

- ***OR***

2.02 GLASS WIDE BODY CURTAIN (9100): 11-1/4 inches wide with 5-1/4 inch high bottom and top plates, truss-like aluminum and 1 inch wide intermediate aluminum plates vertically spaced 12 inches apart; three 15/16 inch vertical rods horizontally spaced 1-7/8 inches on center, covered with 1/2 inch aluminum tubes. Panels connected with two-piece vertical aluminum tubular hinges.

- ***OR***

2.02 PERFORATED STANDARD BODY CURTAIN (9100 or 9200): 7-1/4 inches wide with minimum 4 inch high bottom and 5-1/4 inch high top plates, truss-like aluminum, with 18 gage powder coated perforated steel panels vertically spaced by 1 inch truss-like aluminum inch plates. 4-3/4 inch wide panels have 3/16 holes spaced 1/4 inch on center; 51 percent viewable area. Panels connected with two-piece vertical aluminum tubular hinges.

- ***OR***

2.02 PERFORATED WIDE BODY CURTAIN (9100): 11-1/4 inches wide with minimum 4 inch high bottom and 5-1/4 inch high top plates, truss-like aluminum, with 18 gage powder coated perforated steel panels vertically spaced by 1 inch truss-like aluminum plates. 8-7/8 inch wide panels have 3/16 inch holes spaced 1/4 inch on center; 51 percent viewable area. Panels connected with two-piece vertical aluminum tubular hinges.

- ***OR***

2.02 PERFORATED NARROW BODY CURTAIN (9100): 4-1/8 inches wide with 2 inch high bottom and top plates, truss-like aluminum, with full-height perforated aluminum panels with 3/16 inch holes spaced 1/4 inch on center; 51 percent viewable area. Panels connected with single-piece vertical 5/8 x 1/2 inch aluminum hinges.

- ***OR***

2.02 POLYCARBONATE STANDARD BODY CURTAIN (9100): 7-1/4 inches wide with minimum 4 inch high bottom and 5-1/4 inch high top plates, truss-like aluminum, glazed with 1/8 inch polycarbonate panels vertically spaced by 1 inch truss-like aluminum plates, 4-3/4 inch wide per-panel viewable area. Panels connected with two-piece vertical aluminum tubular hinges

- ***OR***

2.02 POLYCARBONATE WIDE BODY CURTAIN (9100): 11-1/4 inches wide with minimum 4 inch high bottom and 5-1/4 inch high top plates, truss-like aluminum, glazed with 1/8 inch polycarbonate panels vertically spaced by 1 inch truss-like aluminum plates, 8-7/8 inch wide per-panel viewable area. Panels connected with two-piece vertical aluminum tubular hinges.

- ***OR***

2.02 SOLID STANDARD BODY CURTAIN (9100 or 9200): 7-1/4 inches wide with 5-1/4 inch high alternating top plates, truss-like aluminum, with full-height solid aluminum panels; no viewable area. Panels connected with two-piece vertical aluminum tubular hinges.

- ***OR***

2.02 SOLID WIDE BODY CURTAIN (9100): 11-1/4 inches wide with 5-1/4 inch high alternating top plates, truss-like aluminum, with full-height solid aluminum panels; no viewable area. Panels connected with two-piece vertical aluminum tubular hinges.

- ***OR***

2.02 SOLID NARROW BODY CURTAIN (9100): 4-1/8 inches wide with 2 inch high bottom and top plates, truss-like aluminum, with full-height solid aluminum panels; no viewable area. Panels connected with single-piece vertical 5/8 x 1/2 inch aluminum hinges.

2.03 POCKET (9200 only): Welded 1/2 inch tubular steel frame forming 6 inch exterior, 5 inch clear opening width, with 1 inch vertical adjustment.

- Pocket door: Extruded PVC with magnetic strip full height.

2.04 OVERHEAD TRACK: Extruded aluminum, 1-3/8 inches wide x 1-5/8 inches high, continuous profile seamed with alignment bars and track pins at splices. Refer to drawing for layout.

2.05 CURTAIN CARRIERS: Dual bearing trolleys with 1-1/8 inch diameter tires.

2.06 CURVES:

- [None]
- [(90 degree 22 inch) standard radius curved track]
- [(120 degree 10 inch) (135 degree 10 inch) (150 degree 10 inch) standard radius curved track]
- [Special curved track - refer to Drawings for layout and radius]

2.07 POSTS: Provide manufacturer's standard locking posts of aluminum extrusions:

- Lead Post - [Hook bolt/wall channel] [bi-parting/hook bolt] [top & bottom]
- End Post - [Traveling end] [top & bottom] [hook bolt/wall channel]
- Intermediate Post - [not applicable] [Standard spacing] [Closer than standard] Refer to Drawings for post type and placement.

2.08 LOCKING: All thumb turn locking on Grilles will require protection panels

- Lead Post - Interior [None] [thumb turn] [keyed cylinder] Exterior: [None] [keyed cylinder]
- Intermediate Post Interior [not applicable] [non-keyed drop bolt] [keyed cylinder drop bolt]
- End Post - Interior [None] [thumb turn] [keyed cylinder] Exterior: [None] [keyed cylinder]
- Locking for more than one Grille/Closure [keyed alike] [keyed random]
- Key type: [key to Section 087100] [Section 087100 not applicable - manufacturers standard mortise cylinder acceptable]

2.09 Emergency Egress Door:

- [None]
- [Swing out 35 1/2 in. x 79 1/2 in. emergency egress fire exit to meet strict fire code regulations. Egress doors for open air Grilles are constructed with perforated panels. Egress doors for Closures are constructed of corresponding curtain material. Refer to Drawings for placement.]

2.10 OPERATION: Manual push/pull. Provide pull straps - standard on openings over 9 feet in height and countertop applications.

2.11 FINISHES: Aluminum: Anodized clear.

PART 3 - EXECUTION

3.01 EXAMINATION

- Examine site and notify architect of non-specified conditions or construction.
- Advise procedures and corrections necessary to accommodate installation.

3.02 INSTALLATION: C.H.I. products shall be installed and adjusted according to C.H.I. assembly instructions by trained door systems technicians.

3.03 CLEANING AND PRESENTATION

- Clean all finished surfaces for a factory original appearance.
- Replace any damaged components before final inspection.
- Remove all packaging and debris from installation area at the completion of installation
- Present operation and maintenance instructions to owner after demonstrating proper care and operation of the grille.

CLEARANCES & DIMENSIONS (INCHES)

Clearances and dimensions are available upon request for any design layout or allow C.H.I. to assist with your design. Just forward us your floor plan and C.H.I. will offer suggestions of how to best close your opening.

ARCHITECTS

For assistance with specifying or detailing any of our commercial doors call our **AIA Hotline** at 800/590-0559, e-mail us at aia@chiohd.com or fax us at 217-543-4454.

SERIES 9300

Lift Ready Rolling Grilles



The Series 9300 Lift Ready is a revolutionary new design that reduces installation time and effort without compromising security. Choose from four grille patterns that best suit your application.

9300 designs:

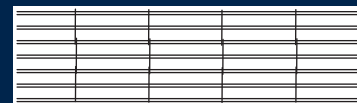

Straight Grille Pattern



Brick Grille Pattern

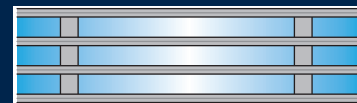

Polycarbonate Panel



Perforated Aluminum

The Life Ready Series comes equipped with the following standard features making installation and operation as easy as possible:

- Classic grille looks offers you security, visibility and ventilation while well engineered design features streamline the installation process to save time and money
- Features a protective clear anodized finish
- Manual push, chain hoist, awning crank, in the tube motor or standard motor operation
- Optional hoods and fascias in steel or aluminum are available for exposed coil applications
- The Quick-Lock System allows the user to engage the lock at a convenient height, then close the grille to the floor where it locks automatically
- The pioneering installation features include the curtain factory wrapped on the aluminum barrel for ease in moving to the site
- Slotted headplates allow for drop in installation of the barrel and curtain eliminating the time needed to center up the curtain
- Built in ratcheting mechanism makes it faster and safer to wind the spring
- The ground breaking optional telescoping support tube system is easier to locate and install than traditional steel tubes



Lift Ready's ratcheting charging arm makes winding the spring easy and safe. And the slotted headplates allow the barrel to drop in place, speeding installation.

Lift Ready's exclusive extruded aluminum telescoping support tubes makes locating the tubes to the site easier.

SPECIFICATIONS

PART 1 - GENERAL

1.01 WORK INCLUDED: Rolling aluminum grilles to be C.H.I. Series 9300.

1.02 RELATED SECTIONS:

- Section 04200 Concrete Block
- Section 05500 Metal Fabrication
- Section 06100 Wall Construction
- Section 08300 Access Doors
- Section 16000 Electrical

1.03 SUBMITTALS

- Furnish all submittals according to guidelines of Division 1 Submittal Procedures.
- Shop Drawings: Furnish shop drawings for architectural approval including elevations and details showing dimensions, finishes, patterns and sections for each grille.
- Product Literature: Submit manufacturer's brochures and literature describing product to be used.
- Provide manufacturer's installation instructions.

1.04 DELIVERY < STORAGE < AND HANDLING

- Refer to Division 1 Material Storage and Handling Requirements
- Deliver and store all materials in manufacturer provided packaging and protect from damage in a safe and dry location.

1.05 WARRANTY: Provide manufacturer's standard two-year warranty (one-year on spring) from date of plant shipment against defects in materials and workmanship.

PART 2 - PRODUCTS

2.01 GENERAL: Items described in the following paragraphs reflect current products manufactured by C.H.I. Overhead Doors, Inc., P.O. Box 260, Arthur, IL, 61911, and may be changed without notice by the manufacturer without penalty or liability.

2.02 CURTAIN: 5/16 inch diameter extruded aluminum rods spaced 1-3/4 inches on center vertically by 1/8 x 5/8 x 4-1/4 inch aluminum links horizontally spaced 9 inches on center and covered by 1/2 inch aluminum spacer tubes on every other rod.

a. Pattern: Straight ***OR*** Staggered (Brick).

OR

2.02 CURTAIN: 3-15/16 inch high panels with 2 inch wide truss-like aluminum end plates with full-width perforated aluminum panels containing 3/16 inch diameter holes spaced 1/4 inch on center; 51 percent viewable area.

a. Panels connected with single piece 5/8 x 1/2 inch horizontal aluminum hinges.

OR

2.02 CURTAIN: 2-3/8 inch high x 1/2 inch deep interlocking extruded aluminum flat slats, 0.062 inch minimum material thickness, with center V-groove.

2.03 BOTTOM BAR: Tubular aluminum extrusion.

2.04 GUIDES: Extruded aluminum, 3 x 1-1/2 inches with shoulders for curtain retention, fitted with vinyl stripping both sides of curtain.

2.05 BRACKET PLATES: Front-loading off-set type of size recommended by grille manufacturer

2.06 BARREL: Aluminum barrel with enclosed helical torsion spring with grease sealed ball bearings or self lubricating graphite bearings for rotating members, sized to grille weight with maximum deflection of 0.03 inch per foot of width.

2.07 SPRINGS: Curtain weight counterbalanced by oil-tempered, helically wound torsion spring, greased packed and mounted on steel torsion shaft. Spring (tension) end of barrel to include ratcheting device to apply tension.

2.07 HOOD AND FASCIAS: Optional - specify 26 gage steel or aluminum.

2.09 LOCKING: Manual push-up grilles furnished with thumb turn lock one side. Optional keyed cylinder lock. Motorized grilles furnished without locks. Optional keyed cylinder or thumb turn. C.H.I. recommended electrical interlocks on motorized grilles with bottom bar locking.

2.10 OPERATION: Manual push-up, awning crank, chain hoist, external motor or in the tube motor operator.

2.11 SUPPORTS: Optional steel tubes or telescoping aluminum tubes and steel channels of size recommended by manufacturer.

2.12 FINISHES: Aluminum: Anodized clear.

PART 3 - EXECUTION

3.01 EXAMINATION

- Examine site and notify architect of non-specified conditions or construction.
- Advise procedures and corrections necessary to accommodate installation.

3.02 INSTALLATION: C.H.I. products shall be installed and adjusted according to C.H.I. assembly instructions by trained door systems technicians.

3.03 CLEANING AND PRESENTATION

- Clean all finished surfaces for a factory original appearance.
- Replace any damaged components before final inspection.
- Remove all packaging and debris from installation area at the completion of installation
- Present operation and maintenance instructions to owner after demonstrating proper care and operation of the grille.

HEADER CLEARANCES & DIMENSIONS (INCHES)

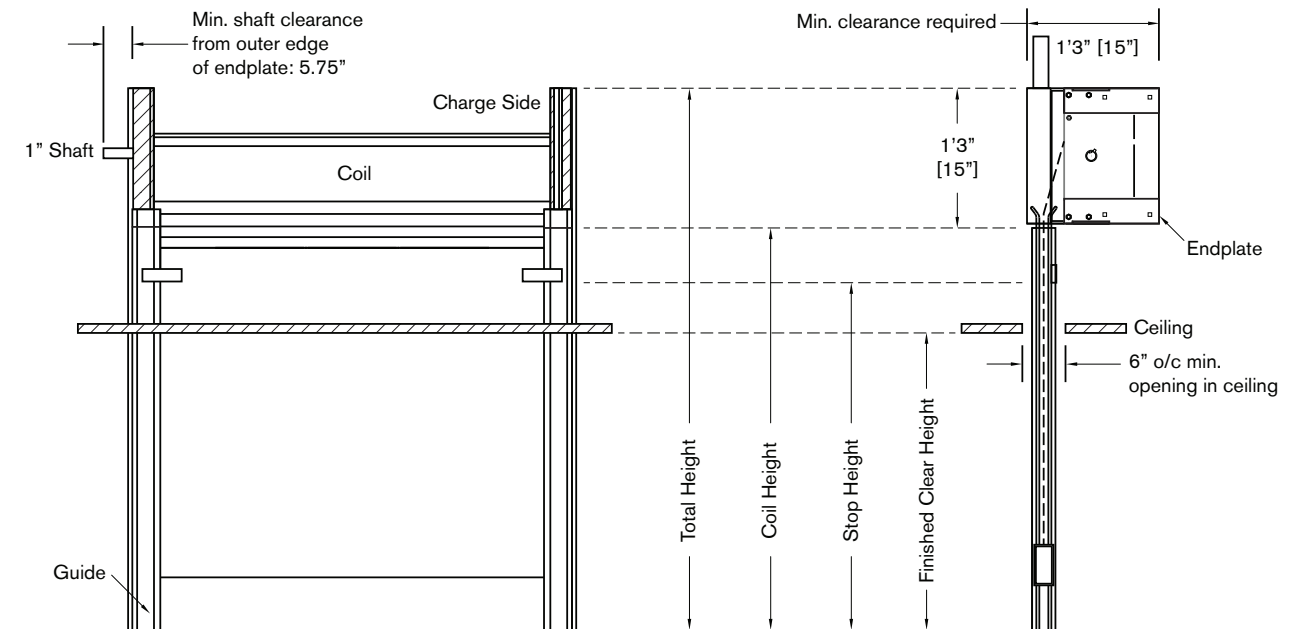

MOUNTING DETAILS

- Between jamb mount
- Lift Ready tube mount
- Steel tube mount
- Face of wall mount E - Aluminum
- Face of wall mount Z - Aluminum
- Face of wall mount E - Steel
- Face of wall mount Z - Steel

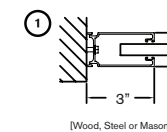

[Wood, Steel or Masonry]

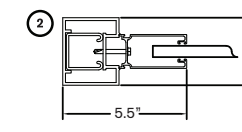

[Aluminum Tube with Telescopic Support]

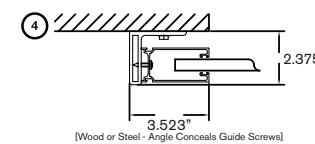
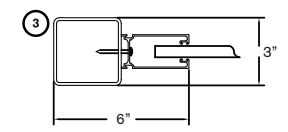

[Wood or Steel - Angle Conceals Guide Screws]

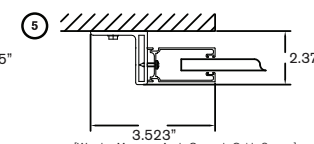

[Wood or Masonry - Angle Conceals Guide Screws]

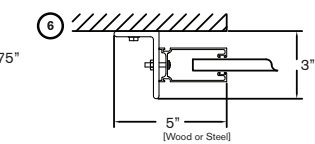

[Wood or Steel]

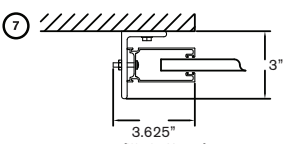

[Wood or Masonry]

MOTOR OPERATION

for Rolling Steel Doors & Shutters

DOOR SELECTION PROCEDURE

- Refer to the motor operator area chart below to select operator type based on door dimensions and gauge.
- You may choose between wall mount or front of headplate mount in the charts below to determine headroom, sideroom and backroom clearance requirements.
- Operator mounting brackets are available for front of headplate mount.
- Front of headplate and wall mount operator covers area available for exterior mount doors.



MODEL H

Heavy-duty for moderate-sized rolling doors using heavy-duty V-belt and chain drive reduction. Available from 1/2 H.P. to 3/4 H.P. single-phase and three-phase operation.



MODEL GH

For larger doors and heaviest use, high-starting torque 40:1 drive reduction using heavy-duty gears running in an oil bath. Available in a variety of horsepower and voltage requirements in single or three-phase operation.

All motor operators are U.L. listed and feature integrated chain hoist, emergency disconnect and a solenoid actuated brake as standard. The standard control is a three-button station (open, close, stop) in a NEMA-1 electrical box. An external radio control terminal is standard for convenient connection. Other controls, timers, safety edges, and sensing devices are available as options.

INERTIA BRAKES

Inertia brakes are available for Series 6000 industrial service doors. Located on the drive shaft, these brakes sense a sudden increase in rpm and apply immediate braking to prevent curtain free-fall.



TUBULAR MOTORS

U.L. rated shutter motors address a broad range of torque requirements with various horsepower, voltage and phase options to cover virtually any shutter application. Our space conscious tube motors require only 1-1/2 inches of additional side room and feature a standard five-year warranty.



WALL MOUNT

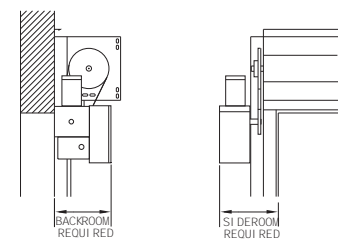

Motor	Sideroom	Backroom
H	21-1/2"	18"
GH	21-1/2"	14-1/2"

FRONT HEADPLATE MOUNT

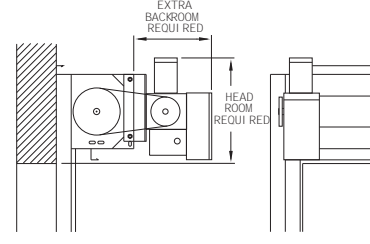

Motor	Extra Backroom	Headroom
H	20-1/2"	23"
GH	17"	30"

HORSEPOWER SELECTION CHART (MAX SQ. FT.)

HP	Type	22 Gauge	20/18 Gauge	Insulated
1/2	H	144	130	120
	GH	144	130	120
3/4	H	200	180	168
	GH	240	200	180
1	GH	400	360	320
1-1/2	GH	540	480	440

SERIES COMPARISON CHART

Comparing C.H.I.'s Rolling Steel Series

Door Model	Insulated	U.L. Rating	Operation	Slat Profile	Gauge	Maximum Size ¹	Finishes [some finishes can be reversed]
6241	No	—	**	Flat	24	12'0" x 14'4"	Gray/White
6220	No	—	**	Curved	22	18'4" x 20'4"	Gray/Gray, Gray/White, Tan/White, Brown/White, Galvanized
6221	No	—	**	Flat	22	18'4" x 20'4"	Gray, White, Tan, Brown or Galvanized with Gray, White, Tan or Galvanized Backer
6222	Yes	—	**	Flat	22/24	18'4" x 16'4"	Gray/Gray, Gray/White, Galvanized
6200	No	—	**	Curved	20	22'4" x 24'4"	Gray/Gray, Gray/White, Galvanized
6201	No	—	**	Flat	20	22'4" x 24'4"	Gray/Gray, Gray/White, Galvanized
6202	Yes	—	**	Flat	20/24	22'4" x 20'4"	Gray, White, or Galvanized with Gray, White, Tan or Galvanized Backer
6180	No	—	**	Curved	18	24'4" x 16'4" or 20'4" x 24'4"	Gray/White or Galvanized
6181	No	—	**	Flat	18	24'4" x 16'4" or 20'4" x 24'4"	Gray, White or Galvanized with Gray, White, Tan or Galvanized Backer
6182	Yes	—	**	Flat	18/24	24'4" x 12'4" or 20'4" x 20'4"	Gray, White or Galvanized with Gray, White, Tan or Galvanized Backer
6522	No	—	***	Small Flat	22	14'4" x 8'4"	Gray/White
6544	No	—	***	Small Flat	Aluminum	14'4" x 8'4"	Clear Anodized Aluminum
6566	No	—	***	Small Flat	Stainless Steel	14'4" x 8'4"	#4 Finish Stainless Steel
7300	No	3-Hour*	Chain Hoist	Curved	22, 20, 18	Max. width 24'0" [up to 9'4" high] Max. height 17'0" [up to 14'4" wide]	Gray/White or Galvanized for all gauges; 22 Gauge Tan/White, Brown/White, Gray/Gray; 20 Gauge Gray/Gray
7301	No	3-Hour*	Chain Hoist	Flat	22, 20, 18		
7400	No	4-Hour	Chain Hoist	Curved	22, 20, 18	Max. width 24'0" [up to 9'4" high] Max. height 17'0" [up to 14'4" wide]	Gray/White or Galvanized for all gauges; 22 Gauge Tan/White, Brown/White, Gray/Gray; 20 Gauge Gray/Gray
7401	No	4-Hour	Chain Hoist	Flat	22, 20, 18		
7310	No	3-Hour*	Manual Push-up	Curved	22 [Heavier available]	12'4" x 10'4"	Gray/Gray, Gray/White, Tan/White, Brown/White, Galvanized
7311	No	3-Hour*	Manual Push-up	Flat	22 [Heavier available]	12'4" x 10'4"	
7410	No	4-Hour	Manual Push-up	Curved	22 [Heavier available]	12'4" x 10'4"	Gray/White or Galvanized for all gauges; 22 Gauge Tan/White, Brown/White, Gray/Gray; 20 Gauge Gray/Gray
7411	No	4-Hour	Manual Push-up	Flat	22 [Heavier available]	12'4" x 10'4"	
7330	No	3-Hour*	McKeon Motor	Curved	22, 20, 18	Max. width 24'0" [up to 16'4" high] Max. height 24'0" [up to 20'4" wide]	Gray/White or Galvanized for all gauges; 22 Gauge Tan/White, Brown/White, Gray/Gray; 20 Gauge Gray/Gray
7331	No	3-Hour*	McKeon Motor	Flat	22, 20, 18		
7430	No	4-Hour	McKeon Motor	Curved	22, 20, 18	Max. width 24'0" [up to 16'4" high] Max. height 24'0" [up to 20'4" wide]	Gray/White or Galvanized for all gauges; 22 Gauge Tan/White, Brown/White, Gray/Gray; 20 Gauge Gray/Gray
7431	No	4-Hour	McKeon Motor	Flat	22, 20, 18		
7340	No	3-Hour*	Micanan Motor	Curved	22 [Heavier available]	13'0" x 12'0"	Gray/Gray, Gray/White, Tan/White, Brown/White, Galvanized
7341	No	3-Hour*	Micanan Motor	Flat	22 [Heavier available]	13'0" x 12'0"	
7440	No	4-Hour	Micanan Motor	Curved	22 [Heavier available]	13'0" x 12'0"	Gray/White or Galvanized for all gauges; 22 Gauge Tan/White, Brown/White, Gray/Gray; 20 Gauge Gray/Gray
7441	No	4-Hour	Micanan Motor	Flat	22 [Heavier available]	13'0" x 12'0"	
7522	No	3 Hour*	Manual	Small Flat	22	10'4" x 8'4"	Gray/White
7522	No	3 Hour*	Awning Crank	Small Flat	22	13'0" x 8'4"	Gray/White
7566	No	3 Hour*	Manual	Small Flat	Stainless Steel	10'4" x 8'4"	#4 Finish Stainless Steel
7566	No	3 Hour*	Awning Crank	Small Flat	Stainless Steel	13'0" x 8'4"	#4 Finish Stainless Steel
9100	No	—	Manual	—	Aluminum	No max. width Max. height 18'0" [on simple layouts]	Clear Anodized
9200	No	—	Manual	—	Aluminum	40'0" x 12'0"	Clear Anodized
9300	No	—	**	—	Aluminum	24'0" x 12'0"	Clear Anodized

¹Available as 3/4 Hour, 1-1/2 Hour or 3 Hour rating. **Manual, chain hoist or motor [depending on size]. ***Manual push-up, awning crank or in-tube motor. ¹Consult factory for larger sizes.

LIMITED WARRANTY

C.H.I. Overhead Doors, Inc. ("C.H.I.") warrants rolling steel doors, shutters and components to be free from defects in materials and workmanship for a period of five (5) years. Model 6241 service doors are warranted for one (1) year. Spring wire is warranted for one year. All warranty periods begin with the date of manufacture. C.H.I.'s obligations are strictly limited to repair or replacement of defective parts and components during the warranty period.

This limited warranty excludes: (1) rust caused by damages or scratching; (2) damage resulting from exposure to corrosive chemicals, corrosive fumes, salt environments including coastal areas, condensation, water or fire; (3) damages caused by accident, improper use, negligent operation, improper installation, improper maintenance or normal wear; (4) shipping, installation or labor charges; (5) defects in paints or coatings used to finish door sections; (6) any product or component which is modified, altered, or not part of the original door, and (7) damages resulting from any circumstances beyond the direct control of C.H.I.

In the event of a defective component, contact the dealer the door was purchased from within fifteen (15) days from discovery of the defect. C.H.I. reserves the right to inspect all products alleged to be defective and to verify eligibility of this limited warranty.

THIS LIMITED WARRANTY EXCLUDES ANY LOSS OR DAMAGE NOT SPECIFICALLY UNDERTAKEN HEREIN, INCLUDING, WITHOUT LIMITATION, ANY CONSEQUENTIAL OR INCIDENTAL DAMAGES, SUCH AS DEATH, INJURY, DAMAGES TO PROPERTY, OR DAMAGES ARISING FROM LOSS OF USE OF ANY PRODUCT OR FACILITY. ALL OTHER WARRANTIES, EXPRESSED OR IMPLIED, INCLUDING ANY WARRANTIES OF FITNESS FOR A PARTICULAR PURPOSE AND OF MERCHANTABILITY, ARE HEREBY EXPRESSLY EXCLUDED.

This warranty is non-transferable.

FINISHES

C.H.I. coiling doors are available in a wide variety of choices and finished with a unique paint coat standard that offers a tan or gray exterior with a white interior; colors may be reversed if desired.

The raw steel is treated with a hot-dipped galvanized coating, followed by a baked-on enamel primer coat and a polyester finish coat. This process becomes the base to which powder-coat is applied.

Select powder-coat options from a palette of 188 colors. RAL numbers are provided for each color to ensure that your selection is consistent and right on target the first time.

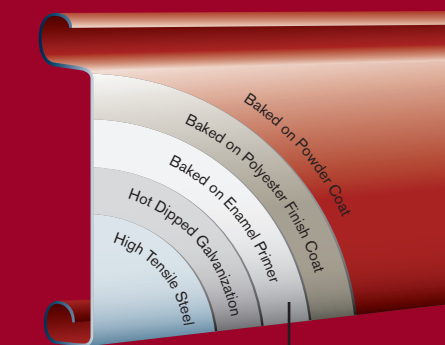

Progressive slat coating process

COLOR SELECTIONS

- WHITE
- TAN
- GRAY
- BROWN

Please note that all color options are not available for all models. Refer to samples at your local C.H.I. distributor for exact color match.